

XR 10

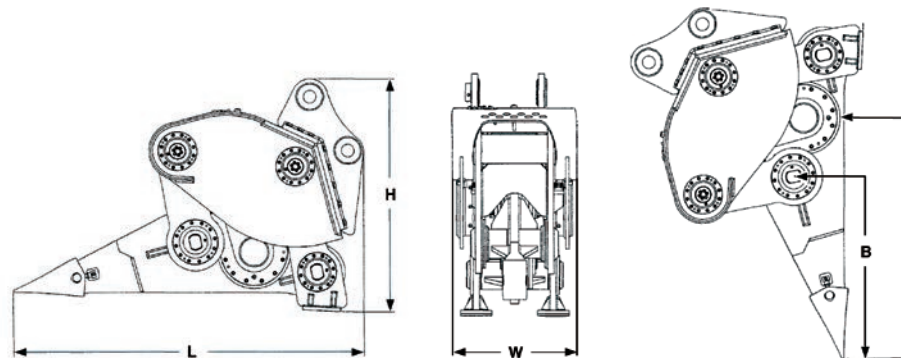

Item		XR 10
Hydraulic excavator	tons	7 - 10
Mass of ripper (incl. top bracket)	kg	930
Mass of ripper (less top bracket)	kg	829
Hydraulic working pressure	MPa	15 - 18
Hydraulic return pressure	MPa	0.6
Hydraulic oil flow	L/min	60
Case drain maximum pressure	MPa	0.4
Frequency	1/min	1500
Dimensions L x W x H	cm	168 x 45 x 90
Dimension A	cm	102
Dimension B	cm	76
Accumulator pressure	MPa	0.6



XCENTRIC RIPPER INTERNATIONAL, S.L.

Arriurdina, 15 · 01015 Vitoria-Gasteiz (Spain) · Tel.: +34 945 290 555

www.xcentricripper.com