

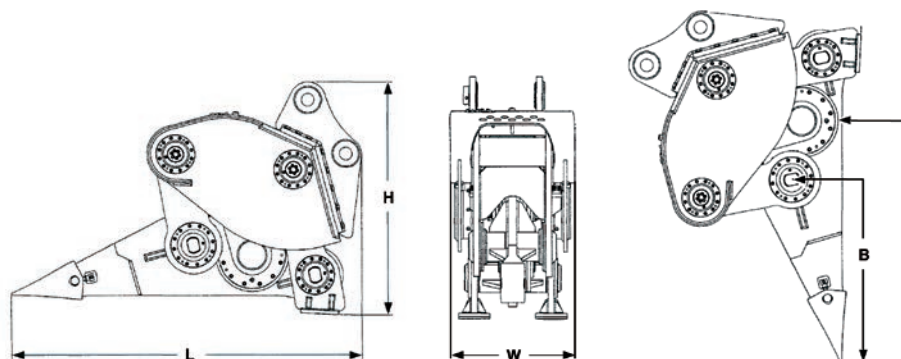

XR 40



Item	XR 40	
Hydraulic excavator	tons	32 - 40
Mass of ripper (incl. top bracket)	kg	4200
Mass of ripper (less top bracket)	kg	3600
Hydraulic working pressure	MPa	22 - 24
Hydraulic return pressure	MPa	0.6
Hydraulic oil flow	L/min	200
Case drain maximum pressure	MPa	0.4
Frequency	1/min	1200
Dimensions L x W x H	cm	310 x 90 x 184
Dimension A	cm	200
Dimension B	cm	155
Accumulator pressure	MPa	0.5



XCENTRIC RIPPER INTERNATIONAL, S.L.

Arriurdina, 15 · 01015 Vitoria-Gasteiz (Spain) · Tel.: +34 945 290 555

www.xcentricripper.com